

# SIAT

MAILLIS

## SM2-1

### Stainless Steel Carton Sealing Machine

Reliable sealing process thanks to our taping heads

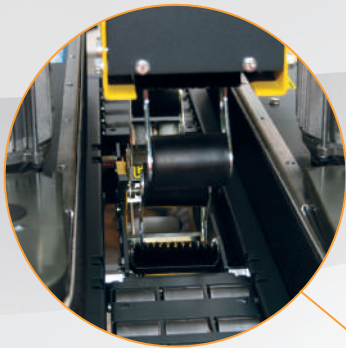

Sturdy "A frame" structure for heavy duty applications

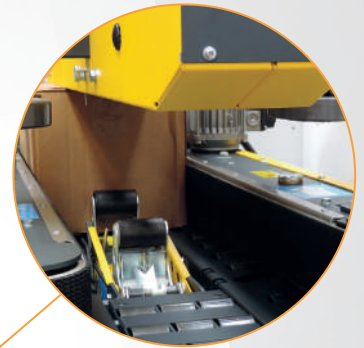

Perfect box control with 2 top + 2 bottom 75mm width side drive belts

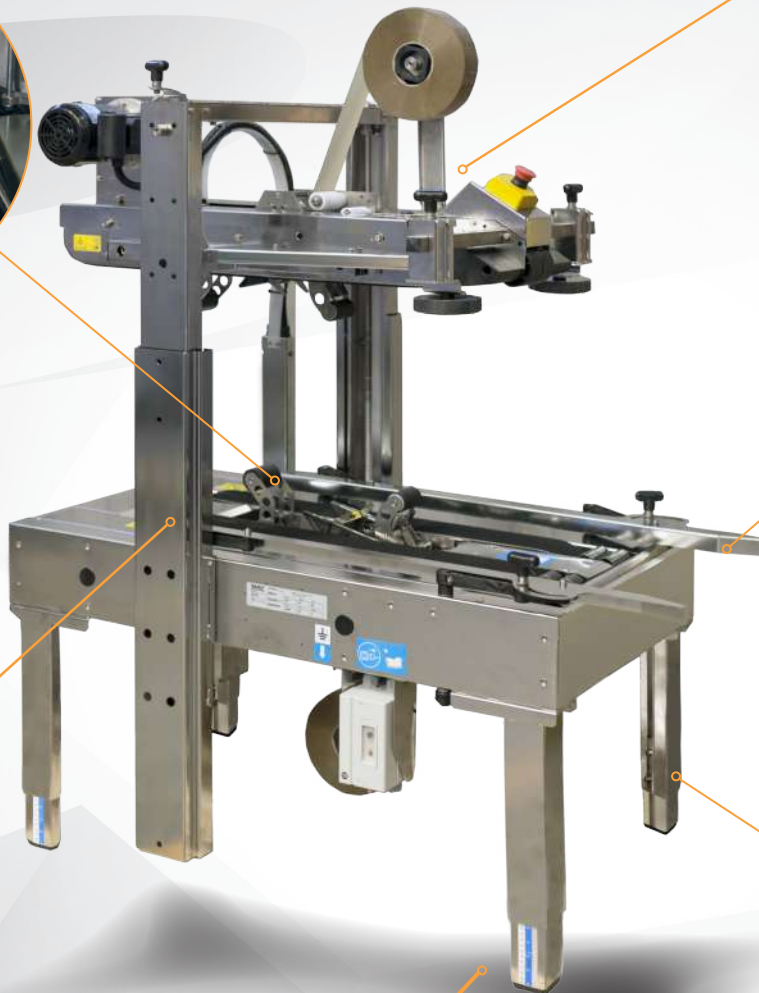

Easy infeed thanks to benchwork rollers

Perfect box control with 2 top + 2 bottom 75mm width side drive belts

All frame and components built in AISI304 stainless steel with electropolish surface treatment

Stainless steel telescopic legs in AISI304

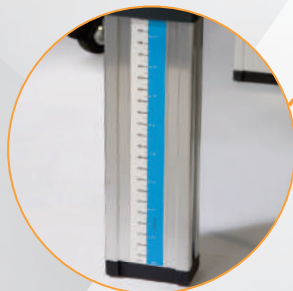

CE

for more details:



The semi-automatic case sealer **SM2-I** is the stainless steel solution in case of uniform size sealing needs.

Thanks to the strong dual mast frame, completely built in AISI 304, SM2 is suitable for environments where an high cleaning level is required.

In fact, it meets the requirements of food production plants, the controlled environments of pharma and cosmetic businesses in addition to the environments with a high rate of corrosion and dispersion of harsh chemicals.

**SM2-I** model has been designed in compliance with CE regulations.



other languages: [www.siat.com](http://www.siat.com)

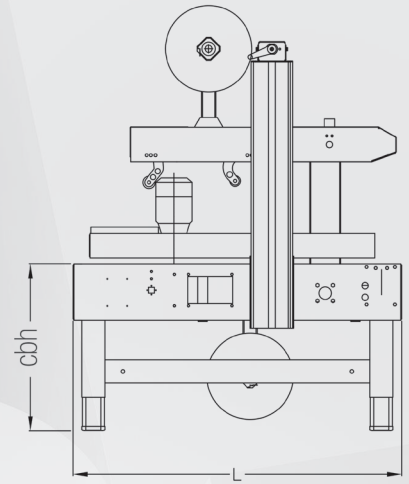
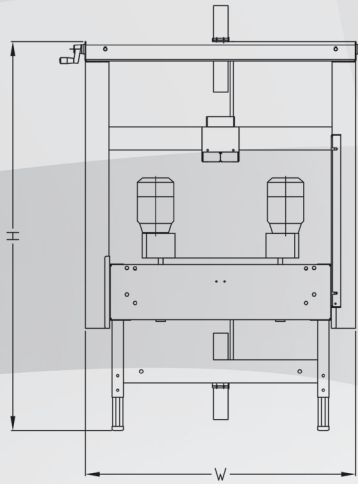

> **Machine dimensions**

Dimensioni macchina  
 Machinemessungen  
 Dimensions machine  
 Dimensiones de máquina

Size / Weight packaging			LxWxH 
> <b>SM2-I</b>	185	220	120x106x116

> **SM2-I**

	Min.	Max
L	938	-
W	1140	-
H	1250	1590
cbh	480	820
AS 77	580	920
AS 80	680	1020

> **Taping units**

Unità nastranti  
 Verschliesseinheiten  
 Unité enrubanneuses  
 Unidades de precinto

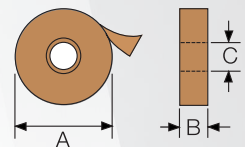

	K11
	mm
A	410 Max
B	50
C	76

> **Box dimensions**

Dimensioni delle scatole  
 Kartonabmessungen  
 Dimensions des boîtes  
 Dimensiones de cajas

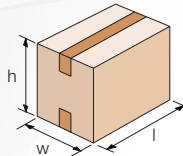

> **SM2-I**

	K11	
	Min.	Max
l	150	∞
w	140 / 170*	500
h	100	500

\* With top side pressure rollers (min. width manageable 205mm)  
 Upper guides required in case of box width less than 205mm (optional)

> **Production capacity**

Capacità di produzione  
 Produktionskapazität  
 Capacité de production  
 Capacidad de producción

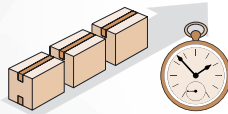

> <b>SM2-I</b>	Bph
Max pcs.*	1200

\* Depending on operator dexterity

> **Standard voltage**

Voltaggio standard  
 Standardspannung  
 Tension standard  
 Voltaje estándar

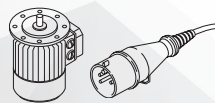

> **SM2-I**

380/415V - 50Hz	
Other voltages available on demand	
Amps	1,08
Power kW	0,26
Phase	3Ph + PE

> **Optionals**

Accessori  
 Zubehör  
 Accessories  
 Accesorios

> **AS80**

Higher legs  
 Set gambe più alte  
 Höhere Stützen  
 Pieds plus hauts  
 Patas más altas



> **AS77**

Castors  
 Set ruote  
 Rädchen  
 Roulettes  
 Ruedas

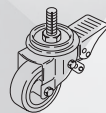

> **RG**

Roller conveyor  
 Piani a rulli  
 Rollenbahnen  
 Plans à rouleaux  
 Rodillos libres



> **GTL - GTR**

Extendable conveyor  
 Rulliera estensibile  
 Ausziehbare rollenbahnen  
 Convoyeur extensible  
 Rodillos extensibles

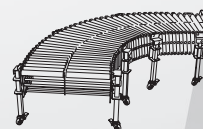

> **K-125 / K-250**

Inkjet printer  
 Stampante ad inchiostro  
 Tintenstrahldrucker  
 Marqueur à jet d'encre  
 Impresora de inyección de tinta

