



SK27

Automation Grade	<i>SEMI</i>	<i>Fully</i>	Use Intensity	<i>Low</i>	<i>MEDIUM</i>	<i>High</i>
Format Setting	MANUAL	<i>Automatic</i>	Box Dimension	<i>Small</i>	MEDIUM	LARGE

DATASHEET

SAFE • SUSTAINABLE • STRONG

Semi-Automatic Case Sealer

The SK27 is a new semi-automatic case sealing machine designed and engineered by SIAT specifically for large and medium fixed sized boxes. SK27 is the ideal case sealing machine for a variety of industries like food and beverage, chemical, clothing, textiles, electronics, furniture and metal containers.

KEY FEATURES

- ✓ **Practical** - Seals upper & lower flaps of cardboard cases or cartons
- ✓ **Added Protection** - Lockable electric isolation switch
- ✓ **Taping Heads** - Available with K11 or K12 taping heads
- ✓ **Faster** - 30 m/min belt conveyor speed option available
- ✓ **Ecological** - energy saving option available
- ✓ **Quality Build** - Best-In-Class components with SIEMENS electrics
- ✓ **New feature** - Top taping head removable
- ✓ **Improved Design** - Quick release Taping Heads (Top & Bottom – No tools required)
- ✓ **CE compliant** - Engineered and produced in Italy according to EU safety standards

MACHINE DIMENSIONS

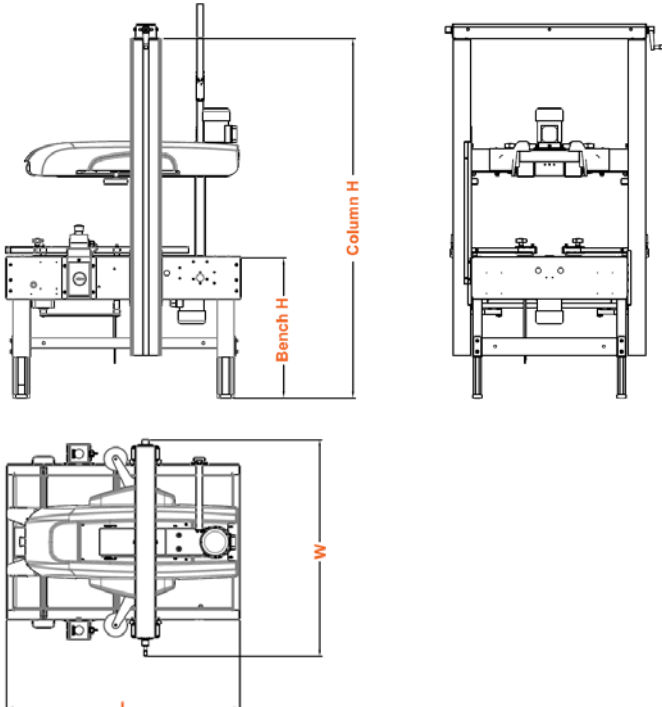

Machine Dimensions			Standard Power Supply	
	Min (mm)	Max (mm)	380/400V - 50Hz - 3ph	
H Column	1.490	1.830	440V - 60Hz - 3ph	
H Bench	485	825	Amps	1,08
W	1010	1010	Power kW	0,26
W Bench	720	720	Phase	3Ph +N + PE
L	1.080	1.080		

SK27



DATASHEET

Technical Data

Belt position	Top + Bottom
Box Size	Medium + Large
Min / Max box weight	0.5 - 32 kg
Default Taping Head	K12 for 3" = 75 mm
Alternative Taping Heads	K11 for 2" = 50 mm
Power Consumption (std.)	0,26 kw
Air Consumption (NL/Cycle)	No air consumption
Operator Side	Left (std.) / Right
Tape width (mm)	75 (std.) / 50
Tape Leg (mm)	70 (std.) / 50 / 30
Ingress Protection Code	IP54
Ambient Operating Temperature	+5° / +40° C
Maximum level of noise	Depending on tape quality

Features

Removable Top Taping-Head	•
Removable Bottom Taping-Head	•
Adjustable Tape Leg	•
Pre-Installed & Easy-To-Mount	•
Adjustable Tape Contact Pressure	•
Autom. Box Format Setting	-
Flap Folding Function	-
Belt Speed Selection	-
Fully Automatic Operation	-
SIAT Taping-Logic on board	-

MORE MACHINE DIMENSIONS

Length x Width	1.080 x 1010
Workbench Width	720
Height H (std. legs)	1.490 – 1.830
Height H1 (std. legs + wheels AS77)	1.600 – 1.940
Height H2 (opt. legs AS80)	1.650 – 1.985
Height H3 (opt. legs AS80 + wheels AS77)	1.760 – 2.095
Workbench Height Z (std. legs)	485 – 825
Workbench Height Z1 (std. legs + wheels AS77)	595 – 935
Workbench Height Z2 (opt. legs AS80)	645 – 980
Workbench Height Z3 (opt. legs AS80 + wheels AS77)	755 – 1.095

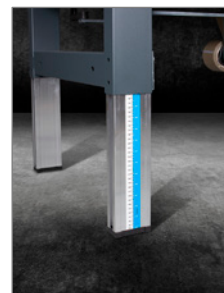
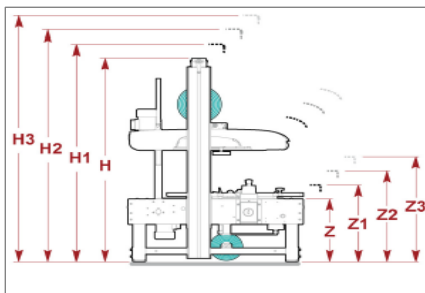

SPECIAL VERSIONS

Special Versions according to individual application and safety requirements are possible on request.

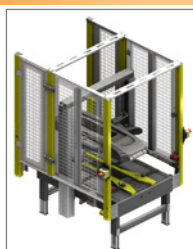

BOX DIMENSIONS & PRODUCTIVITY

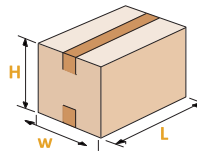

Box Dimensions	L (mm)	W (mm)	H (mm)
Min.	150	170	120*
Max.	∞	650	700**

* 100 mm high box manageable with 50 mm tape leg
120 mm high box manageable with 70 mm tape leg

** possibility to lift the columns up on second position for max 950 mm height (keeping the min of 120 mm)

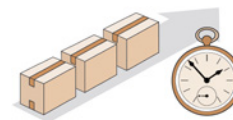

Max. production capacity:
Up to 1200* BPH

*Based on the shortest processible box length and provided an optimum continuous box infeed by the operator.

PROCESSABLE TAPES

Base Material	PVC / OPP / PET / Paper*
Adhesive Type	Solvent / Hot Melt / Acrylic
Special Tape	Filament-Tape** / Safety-Seal-Tape***

*with limitations **special tape cutting blade required ***need of a test might be necessary

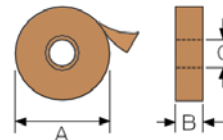

K11R / K12R	
A	Max. 410 mm
B	50 / 75 mm
C	76 mm

BOX REQUIREMENTS

Quality result of the taped box depends on the general box quality and dimensional accuracy, as well as the quality of tape used.

Box Types: FEFCO 0201 – RSC
[other types may be possible as well]

Adverse Impact Factors	Underfilling	Overfilling	Weak Boxes

OPTIONS & ACCESSORIES

- Operation side "Right" (std. "Left")
- Special cutting blades filament-tape
- Taping Head for 50mm width
- Power Supply 220/230V – 50hz – 1ph
- Higher Legs
- Casters / Wheels
- Fix / Extendable Roller Conveyors
- Safety fences
- 30 m/min belt speed (std. 22)
- Energy Saving Kit
- End/Break Tape Device

MORE DETAILS

Videos and further information can be found on our website or SIAT Youtube channel.