

Clippatrici.
Manuali elettriche
Clipping Machines.
Manual Electric

Scheda tecnica
Technical Sheet

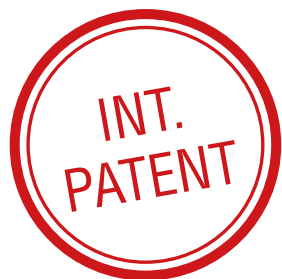

ComiPak
ENGINEERING



M358PL
M408PL
M508PL
M608PL
M355/M357DP
M405/M407DP

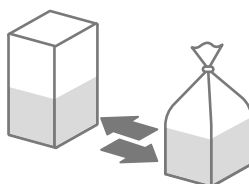

Applicano la chiusura salva-freschezza in plastica "clipband" o il sigillo di garanzia in alluminio a confezioni alimentari già riempite. Il sacchetto viene inserito manualmente dall'operatore all'interno del passaggio macchina. Start ciclo con micro elettrico.







They apply a plastic "clipband" as fresh-saver or aluminium band as "warranty-seal" to already filled food bags. Manual infeed by operator into machine passage. Start cycle by micro mechanics.

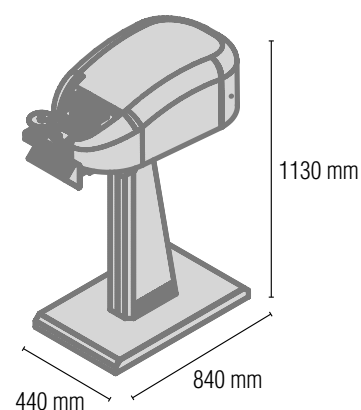

comipak.com

Dati e modelli Models and Technical Data



	M358PL	M408PL	M508PL	M608PL	M355/M357DP	M405/M407DP
Tipologia sigillo Closure Type	 Clipband plastica Plastic Clipband	 Clipband plastica Plastic Clipband	 Clipband plastica Plastic Clipband	 Clipband plastica Plastic Clipband	 Sigillo alluminio Aluminium Band	 Sigillo alluminio Aluminium Band
Lunghezza sigillo mm Closure Length mm	35	40	50	60	35	40
Alimentazione Operation	Elettrica Electric	Elettrica Electric	Elettrica Electric	Elettrica Electric	Elettrica Electric	Elettrica Electric
Potenza elettrica Electric Power	110V 50/60Hz 1PH+N+PE 230V 50/60Hz 1PH+N+PE	110V 50/60Hz 1PH+N+PE 230V 50/60Hz 1PH+N+PE	110V 50/60Hz 1PH+N+PE 230V 50/60Hz 1PH+N+PE	110V 50/60Hz 1PH+N+PE 230V 50/60Hz 1PH+N+PE	110V 50/60Hz 1PH+N+PE 230V 50/60Hz 1PH+N+PE	110V 50/60Hz 1PH+N+PE 230V 50/60Hz 1PH+N+PE
Consumo elettrico Power Consumption	100 Watt	100 Watt	100 Watt	100 Watt	100 Watt	100 Watt
Max diametro chiusura mm Max. Closure Diameter mm	10	15	20	25	10	15
Capacità meccanica/minuto Mechanical Capacity/Min	40	40	40	40	40	40
Capacità produttiva/minuto Production Capacity/Min	20-30	20-30	20-30	20-30	20-30	20-30
Peso netto/lordo Kg Net/Gross Weight Kg	50/60	50/60	50/60	50/60	50/60	50/60
Dimensioni imballo mm Packing Dimensions mm	950x680x650	950x680x650	950x680x650	950x680x650	950x680x650	950x680x650
Datario Date Printer	Optional	Optional	Optional	Optional	Di serie Standard	Di serie Standard

Aggiornamento scheda: luglio 2019. Updating sheet: Juli 2019.

Optionals

Datario incisione, Datario inchiostro, Datario Hotfoil, Datario HP, Pedale
Embossing Printer, Ink Printer, Hotfoil Printer, HP Printer, Footswitch

L'uso ridotto di energie contribuisce al rispetto dell'ambiente.
Low energy consumption contributes to environmental respect.



ComiPak
ENGINEERING

Comi Pak Engineering srl - via Lago di Tovel, 6i Z/I.2 - 36015 Schio (VD) - Italy
T +39 0445 575631 - +39 0445 1925747 - F +39 0445 500390 - info@comipak.com

comipak.com