



# SM44HD

NASTRATRICE A DIMENSIONAMENTO AUTOMATICO PER DIVERSI FORMATI DI SCATOLE CON CHIUSURA AUTOMATICA DELLE FALDE SUPERIORI  
 AUTOMATIC CASE SEALER FOR RANDOM SIZE CASES WITH AUTOMATIC CLOSING OF THE UPPER FLAPS  
 MACHINE D'EMBALLAGE AUTORÉGABLE SUR LES DIFFÉRENTS FORMATS DE BOÎTES AVEC FERMETURE AUTOMATIQUE DES RABATS SUPÉRIEURES  
 VOLLAUTOMATISCHE SELBSTÄTTIGERE MASCHINE GEMÄß DER VERSCHIEDENEN SCHACHTELFORMATE MIT AUTOMATISCHEM VERSCHLUSS DER OBEREN KLAPPEN  
 PRECINTADORA AUTOMÁTICA PARA CAJAS DE FORMATO VARIABLE CON CIERRE AUTOMÁTICO DE LAS SOLAPAS SUPERIORES

- Pannelli di protezione in Lexan®
- Lexan® safety protection panels
- Panneaux des protections on Lexan®
- Schutze aus Lexan® gegen Unfälle
- Paneles de proteccion en Lexan®



- Pannelli di protezione in metallo (Opzionali)
- Metal safety protection panels (Optional)
- Protections métalliques (Optional)
- Schutze aus Metall gegen Unfälle (Optional)
- Paneles de proteccion en metal (Opcional)

- Regolatore di pressione pneumatico
- Air-pressure regulator
- Régulateur de pression pneumatique
- Druckregler
- Regulador de presión neumático

- Ruote pivotanti con freno (Opzionali)
- Guide roller with brake (Optional)
- Roues tournoyantes avec frein , (optionnel)
- Rotierende Räder mit optionellen Bremsen
- Ruedas girante con freno (Opcional)

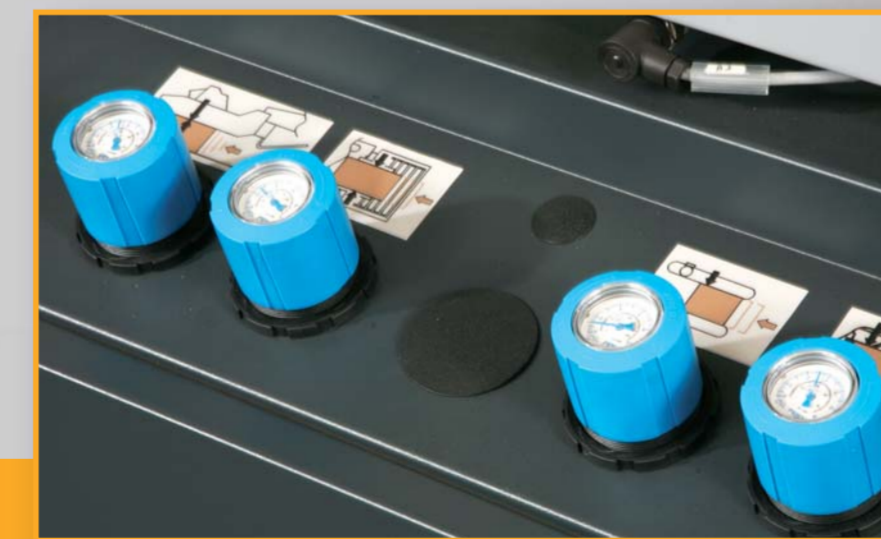

- Pannello di controllo per regolazioni pneumatiche
- Control panel for the pneumatic adjustment
- Panneau de commande pour les réglages pneumatique
- Schaltfeld zur pneumatischen Einstellungen
- Cuadro de control neumático

- Selettore scelta modo d'uso: Multiformati, Formato fisso, solo Transitò
- Selector switch user instructions: random size, uniform size, transit only
- Sélecteur choisi d'usage: plusieurs formè, fixe formè, seul passage
- Gebrauchsweise: Vielformat, Fixes Format, nur Durchgang
- Interruptor con opcion de uso: autodimensionante - ajuste manual - solo transitò



- Pannello di controllo su consolle esterna
- Control panel on external module
- Panneau de commande sur armoire extérieure mobile
- Schaltfeld auf äusserliche bewegliche Konsole
- Cuadro de control en consola externa móvil

- AS24: Alimentatore centratore con barriera di fermo scatole
- AS24: Centering unit with box holder
- AS24: Centreur avec tapis motorisé et système arrête boîtes
- AS24: Zentriergerät mit beweglichem und Schachtfeststellvorrichtung
- AS24: Centrador con plano móvil e barrera de parada de la cajas

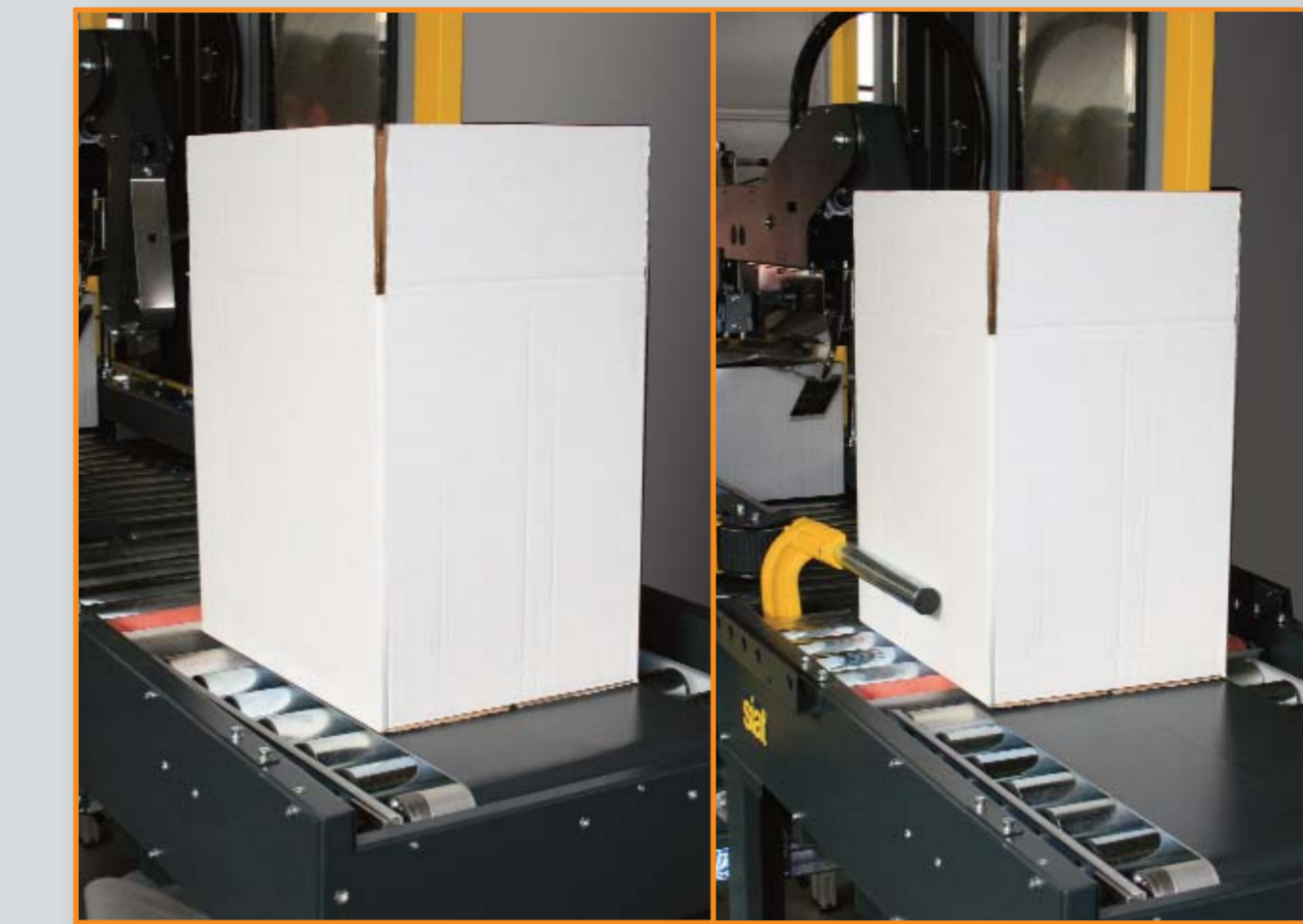

- Ripiegatura delle falde superiori in automatico
- Automatic top flaps folding device
- Fermature des rabats supérieures en automatique
- Automatische Kontrolle und Verschluss der oberen Falten
- Control y cierre de las solapas superiores en automático

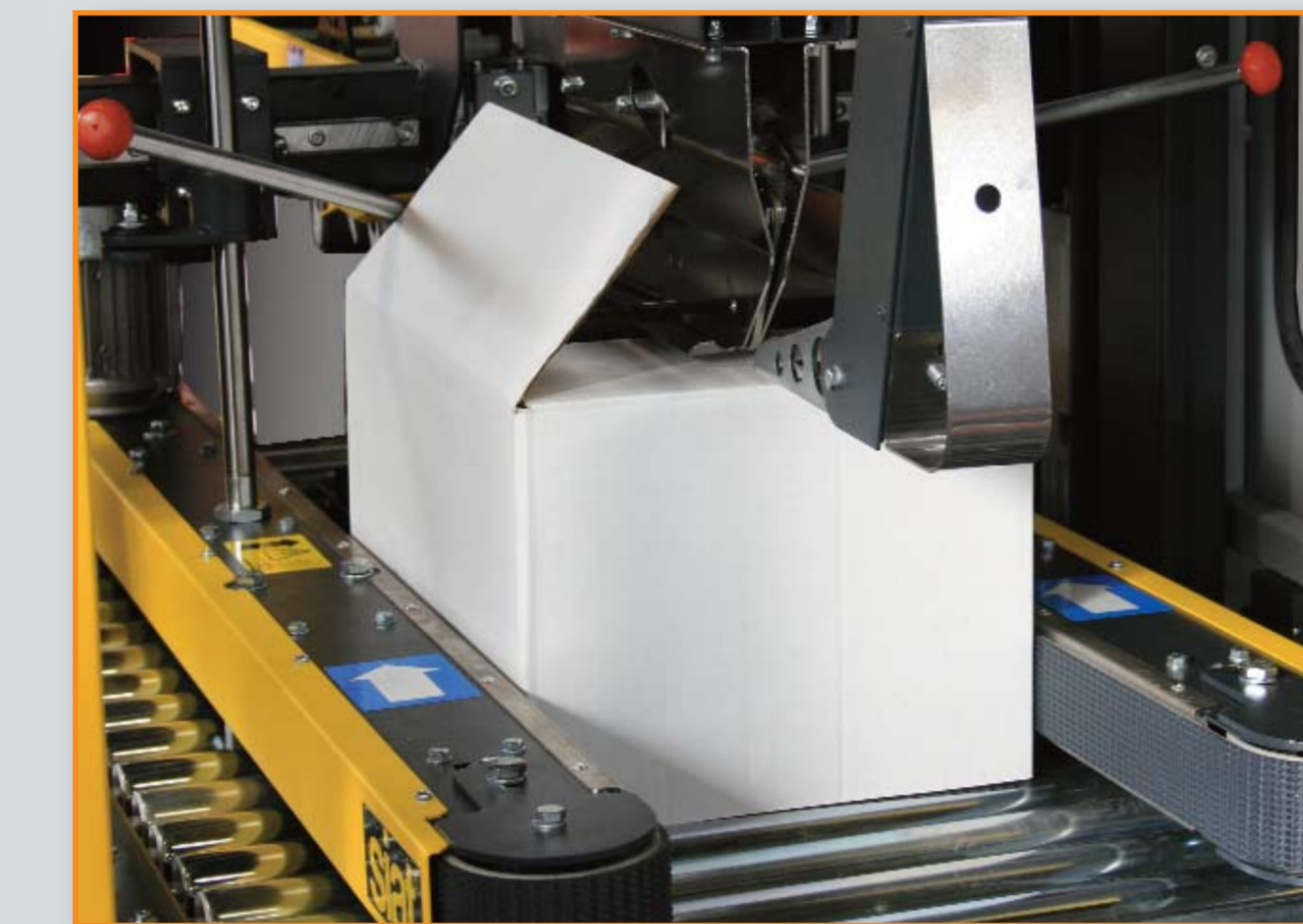

- Unità nastrante Superiore/Inferiore per bobina nastro Ø 410 mm
- Top and Bottom taping heads for tapes Ø 410 mm
- Unité d'enrubannages Supérieure/Inférieure pour rouleau Ø 410 mm
- Obere und Untere Eiheit mit Rollenhalt für Rollen Ø 410 mm
- Unidad de precintado Superior/Inferior para bobina Ø 410mm

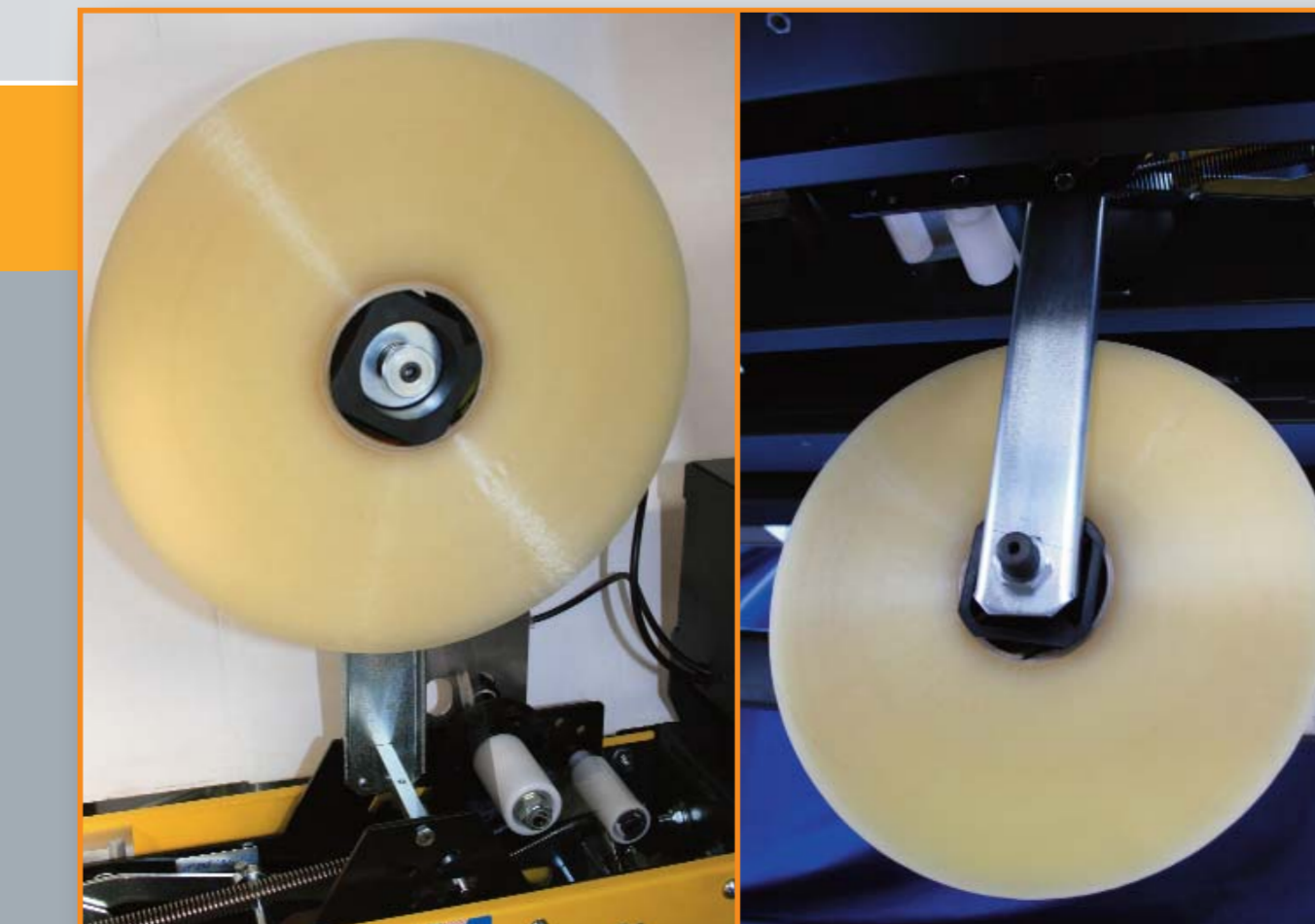

- Rilevatore pneumatico altezza scatole
- Height boxes pneumatic detector system
- Détecteur pneumatique hauteur boîtes
- Datenerheber Preßluft Höhe Schachteln
- Detector neumático altura cajas



- Pressatori laterali per accostamento falde
- Side pressing roller to control flap box closing
- Roules presseurs latéraux pour control rabat boîtes
- Seitliche Anpresser für Schachtelchenkellänge
- Rodillos prensadores laterales de las solapas de la caja



- Sistema di controllo Fine/Rottura nastro (Opzionale)
- Low/brake tape sensor device (Optional)
- Systeme de controle Fin/Rupture ruban (Optional)
- Kontrollsysteme für Band-Ende/Unterbruch (Optional)
- Sistema de control Fine/Rotura cinta (Opcional)

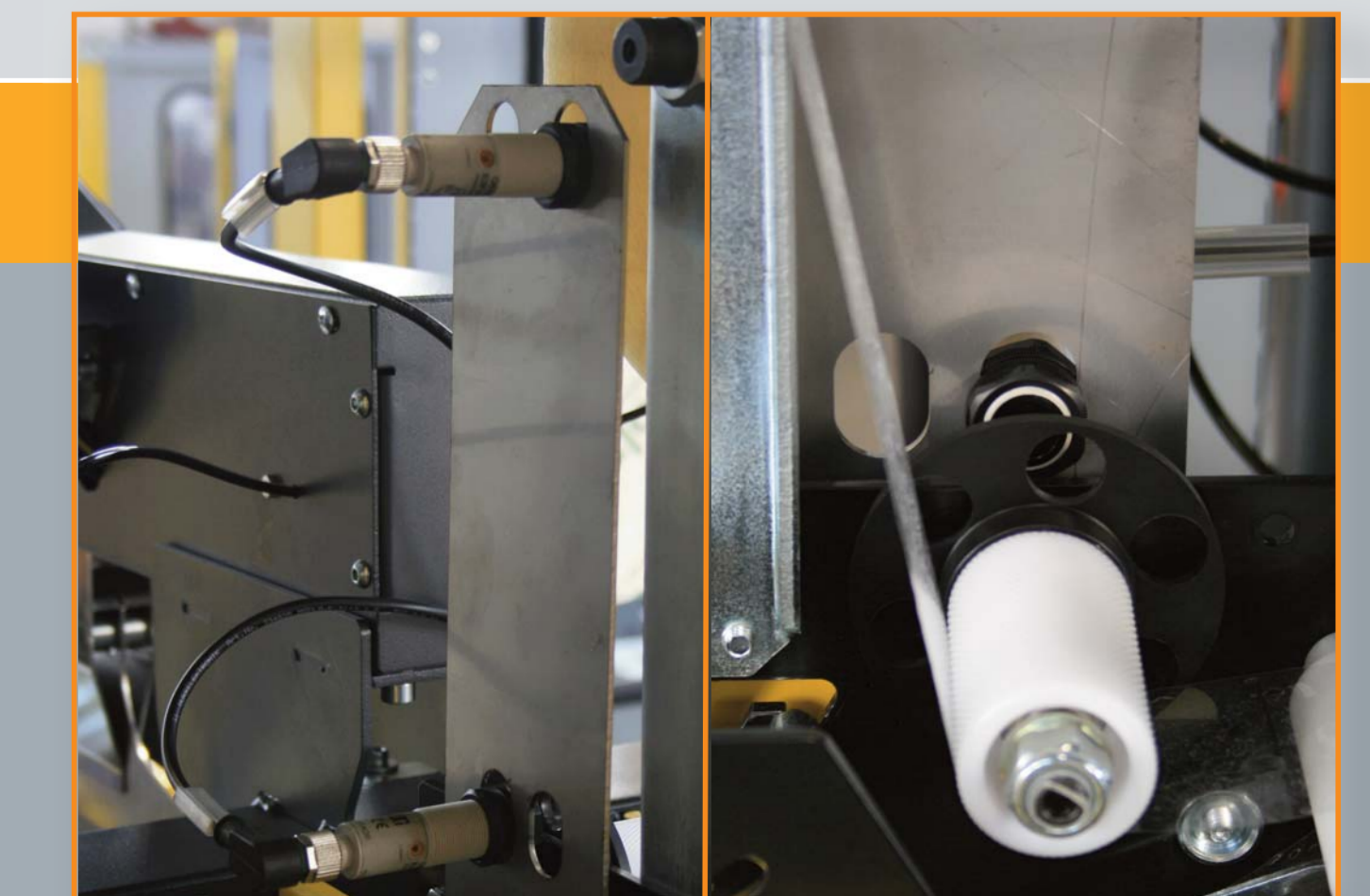

**Ciclo di Lavoro**  
 Scatole di diverso formato, provenienti da varie linee di confezionamento, vengono posizionate al centro della macchina e distanziate dall'AS24 (Centratore /Distanziatore/Cadenziatore).  
 La SM44 si dimensiona automaticamente sui diversi formati di scatole e ne chiude le falde superiori.  
 Tramite le cinghie di trascinamento laterali, le scatole transitano sulle unità nastranti che procedono simultaneamente alla nastratura delle falde superiori ed inferiori con nastro adesivo.



**Working cycle**  
 Different size cases, coming from different filling stations, are centered and indexed by the AS24 (centering / indexing / timing).  
 The SM44 is automatically randomizing on the various size of the boxes and closing the upper flaps.  
 Through the side driving belts, the boxes on transit on the taping unit who simultaneously move to the top and bottom flap sealing with tape.



**Cycle de travail**  
 Boîtes de différent formats, provenant de lignes différentes d'emballage, elles sont positionnées au centre de la machine par l'AS24 (centreur/convoyeur/dispositif de cadence). Le SM44 se règle automatiquement sur les différents formats de boîtes et elle en ferme les rabats supérieurs. Par les courroies de entrainement latéral, les boîtes passent sur les unités d'enrubannage qui procèdent a fermer les rabats supérieurs et inférieurs simultanément avec ruban adhésif.



**Arbeitszyklus**  
 Die Schachtel, die aus verschiedenen Füllungslinien einkommen, werden durch die Zuführungseinrichtung AS24 zentriert und vereinzelt (Beschickungsvorrichtung).  
 SM44, automatische selbstätigere Maschine gemäß der verschiedenen Schachtelformate; sie verschließt die oberen Klappen.  
 Mittels die seitlichen Antriebsriemen fahren die Schachtel auf den Verschlusseinheiten durch, die die oberen und unteren Klappen mit Klebeband gleichzeitig schliessen.



**Ciclo de trabajo**  
 Diferentes medidas de cajas, llegando desde diferentes estaciones de llenado, son centradas y temporizadas mediante el (dispositivo) AS24 (centrador, separador y temporizador). La SM44 está capaz de acostumbrarse automáticamente a las diferentes dimensiones de las cajas y de cerrar las hojas superiores de las cajas. Mediante las bandas de arrastre laterales, las cajas avanza en el cabezal de precintado el cual cierra /mueve las solapas superiores e inferiores con precinto adhesivo.

Caratteristiche tecniche  
 Technical specifications  
 Caractéristique techniques  
 Technische Eigenschaften  
 Características técnicas

# SM44HD

Caratteristiche tecniche  
 Technical specifications  
 Caractéristique techniques  
 Technische Eigenschaften  
 Características técnicas

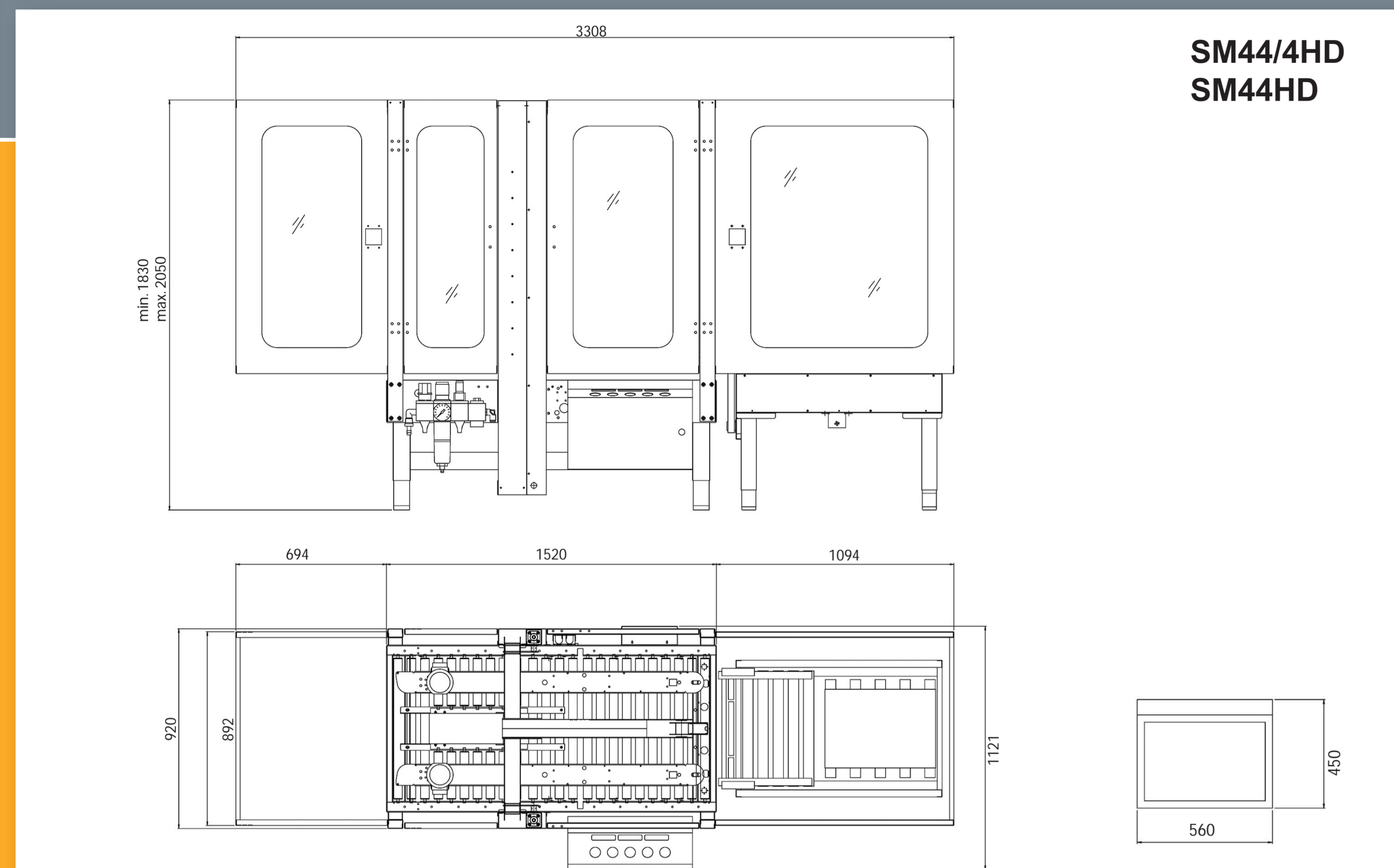

**SM44/4HD**  
**SM44HD**

Dimensioni delle scatole  
 Box dimensions  
 Dimensions boîte  
 Kartonabmessungen  
 Dimensiones de las cajas

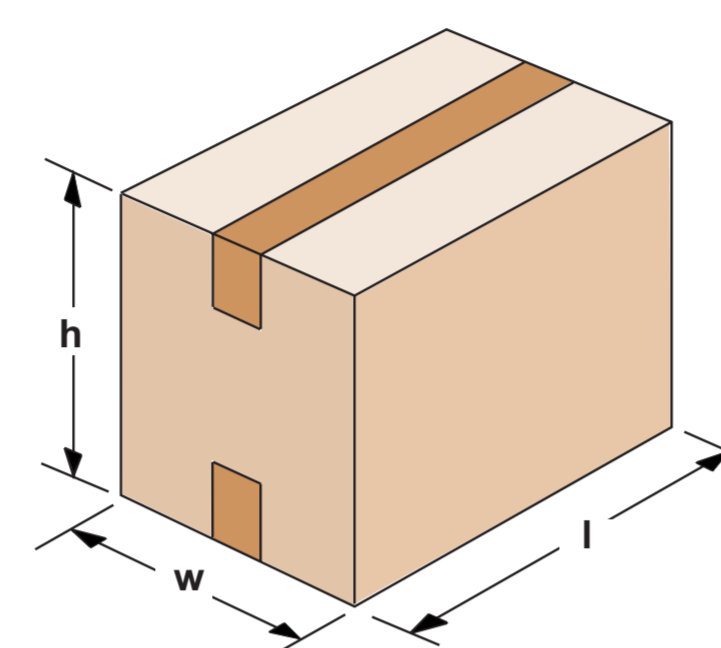

SM44HD		
	MIN	MAX
<b>l</b>	200	600
<b>w</b>	150	500
<b>h</b>	140	500

SM44/4HD		
	MIN	MAX
<b>l</b>	200	600
<b>w</b>	150	500
<b>h</b>	100	460

SM446HD		
	MIN	MAX
<b>l</b>	300	800
<b>w</b>	200	650
<b>h</b>	220	750

220-400-440V	Trifase 3 Phase tri-phasé 3-phasing Trifaseico	220-240V	Monofase Single phase Mono-phasé 1- phasing Monofasico
<b>620 Watt</b>	Assorbimento elettrico Electrical absorption Absorption électrique Elektrische Aufnahme Absorción eléctrico		

Consumo aria Air consumption Consumation air comprimé Druckluftverbrauch Consumo de arie	9lt./ciclo 9 lt./cycle 9 lt./cycle 9 Lt./Zyklus 9 lt./ciclo

		K11	
	<b>A</b>	410 mm max	
	<b>B</b>	50 mm	
	<b>C</b>	76 mm	

		K12	
	<b>A</b>	410 mm max	
	<b>B</b>	75 mm	
	<b>C</b>	76 mm	

**Accessori - Optionals - Accessories - Zubehör - Accesorios**

<b>AS80</b> Set gambe più alte (600mm) Higher legs (600mm) Piedes plus hauts (600mm) Höhere Beine (600mm) Juego de patas altas (600mm)		<b>AS77</b> Set ruote Casters Roues Satz Umlaufräder Set ruedas	
---	--	--	--

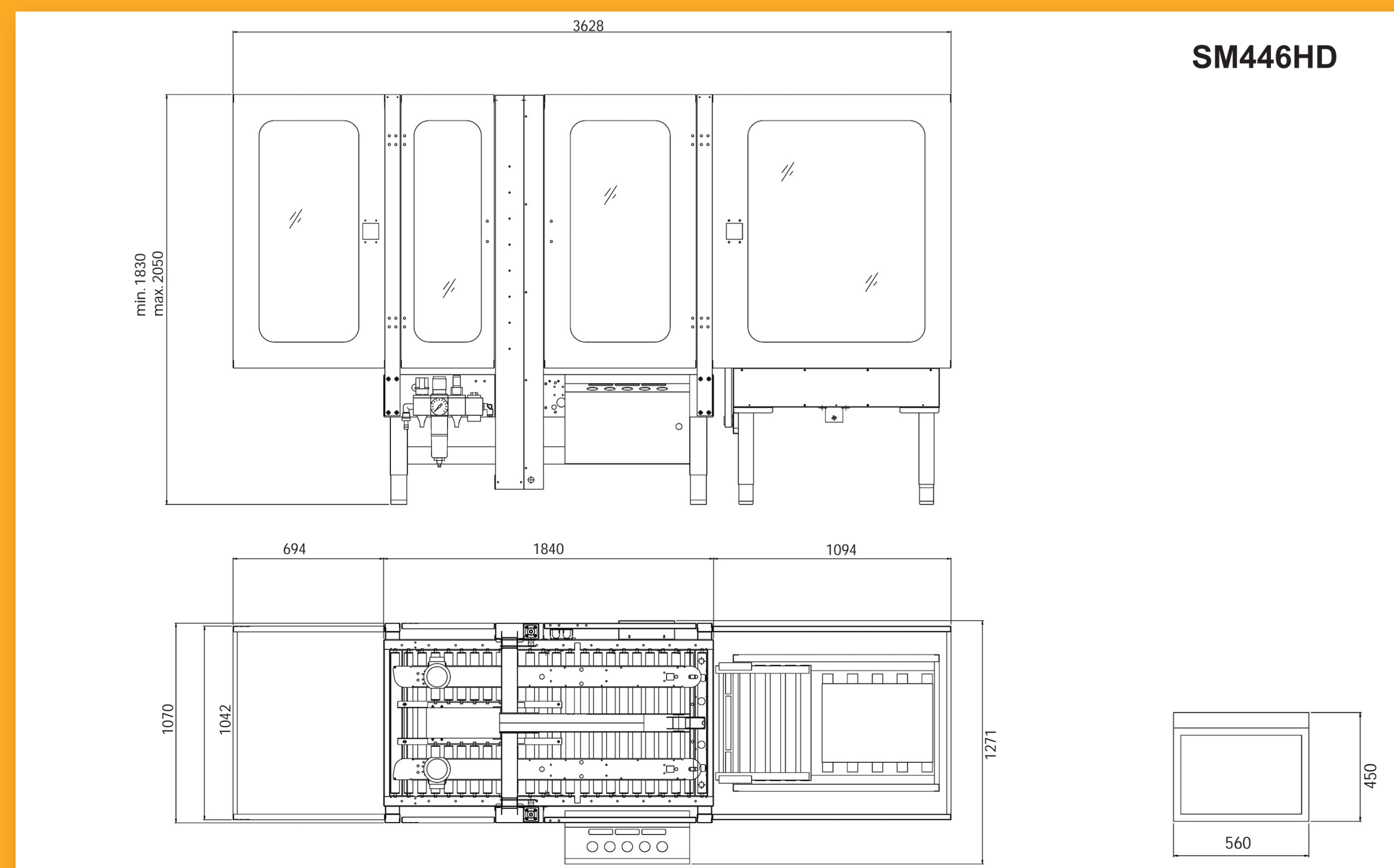

**SM446HD**

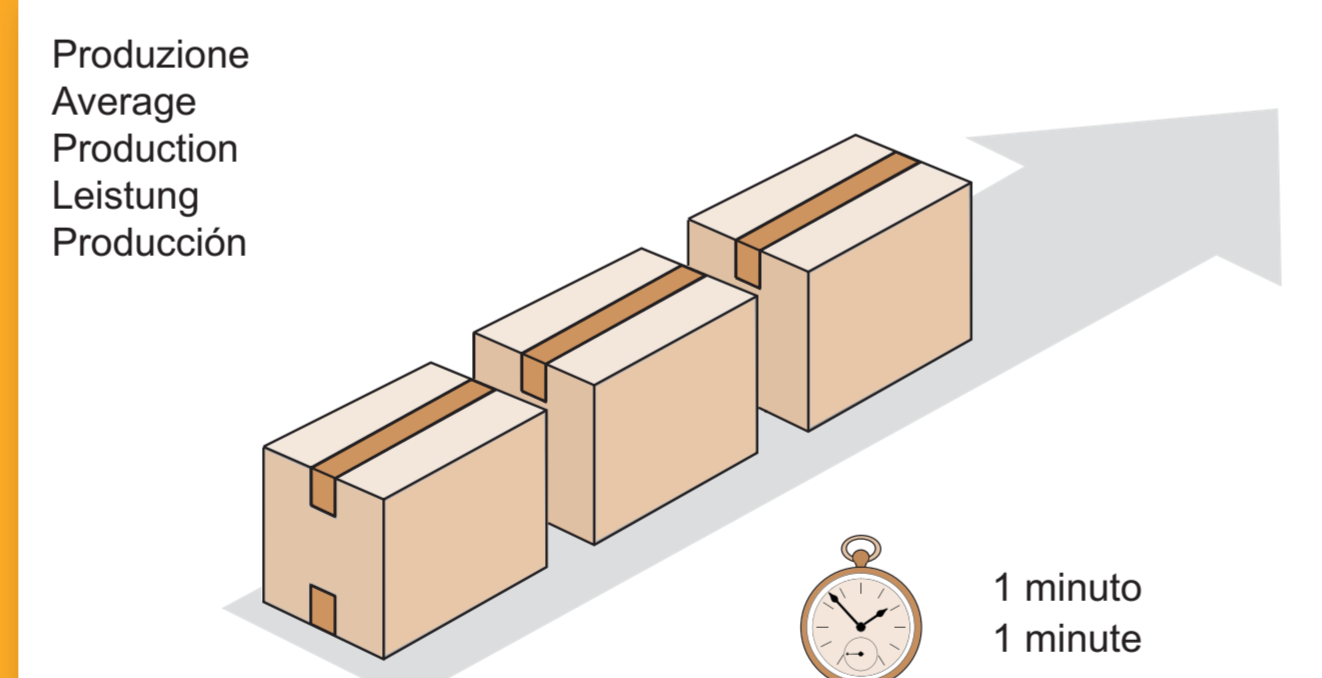

Produzione media Average output Production moyenne Leistung Producción media	8÷10
Produzione speciale With special changes Avec modifications special Mit Sonderänderungen En ejecución especial	9÷11

<b>HD50-1-2-3</b> Rulliera motorizzata ad accumulo Motorized roller conveyors Plans à rouleaux motorisé Motorisiert Rollenbahnen Tramo de rodillos motorizado

<b>GTM - GTL - GTR</b> Piani estensibili Extendable conveyors Convoyeurs extensibles Ausziehbare rollenbahnen Plano de rodillos extensibles

**SIAT** S.p.A. Via Puecher, 22 - 22078 Turate (CO) Italy • Tel +39.02.964951 • Fax +39.02.9689727  
 www.siat.com • siat@siat.com



# SM44HD

NASTRATRICE AUTOMATICA AUTODIMENSIONANTE  
 AUTOMATIC CASE SEALER FOR RANDOM SIZE CASES  
 MACHINE D'EMBALLAGE AUTOMATIQUE AUTOREGLABLE  
 VOLLAUTOMATISCHE VERSCHLISSMASCHINE  
 PRECINTADORA AUTOMATICA PARA CAJAS VARIABLE

Cod. pubbl.: SBC0010228